



VF-45TM Fiber Optic Connector Quick Install Kit

Instructions

January 2004
78-8097-8734-0-C

1.0 3M™ VF-45™ Fiber Optic Connector Quick Install Kit Contents



- Cable Jacket Stripper
- Snips
- Buffer Stripper
- Duplex Stripper
- Puck Assembly
- Cotton Swabs
- Lint Free Cloths
- Alcohol Bottle
- Polishing Station
- Lapping Film
- Carrying Case
- Tool Pouch
- Instructions
- Cleaning Wires
- Fiber Microscope (with three adapters and case)
- Removable Cleave Blade

Warning: *Do not touch cleave blade. Any material or solvent that contacts the blade can cause damage.*

2.0 Features

The 3M™ VF-45™ Fiber Optic Connector Quick Install Kit is used to field terminate VF-45 multimode and single mode sockets. The VF-45 sockets are dual optical fiber connectors that are primarily used in fiber-to-the-desk LAN applications. The duplex fibers are terminated simultaneously using this tool kit.

The VF-45 Fiber Optic Connector Quick Install Kit has the following hardware features and benefits:

- a) Carrying case for ease of use with compartments for all required tools.
- b) Integrated installation tool comprising:
 - Easy scribe and break of fibers to prepare for polishing
 - Fiber stub catcher
 - Slip resistant polishing base
 - Tool pouch storage for all hand tools
 - Adhesive backed lapping film for polishing
 - Versatile dual illumination microscope with adapters for inspection of:
 - 1) Polishing puck end-face
 - 2) Patch cord plug-fibers
 - 3) Standard ferruled connectors
- c) All fiber measurements made with hand tools (no precise measuring)
- d) Easy fiber insertion and socket assembly
- e) Audible click verifies socket assembly
- f) Cleaning with cotton swab
- g) Quick assembly of VF-45 socket
- h) Angle polishing for low loss, low reflectance connections
- i) Replaceable polishing pad
- j) Replaceable scribe assembly
- k) Replaceable polishing face

Caution: *Wear safety glasses during all work operations.*

3.0 3M™ VF-45™ Socket

3.1 Contains the following:

- a) Housing
- b) Socket fiber holder (SFH)
- c) Boot
- d) Base

Note: The VF-45 Socket is sold separately.

4.0 Installation

4.1 Position polishing base.

At the patch panel area, place the polishing base on the patch panel work tray or on a nearby suitable surface. At the work area outlet, choose a suitable surface. Open the hinged scribe cover.

Attach a sheet of lapping film to polishing surface of the station. Removal of the release liner from lapping film exposes adhesive backing to secure the lapping film to the polishing surface.

Tech Tip: Before placement of the lapping film, clean the polishing surface with a lint free wipe moistened with isopropyl alcohol. Lapping film will last for about 50 connectors.

Tech Tip: All Isopropyl Alcohol should be reagent grade, 99% or better. The use of inferior alcohol will adversely effect interconnect losses. This can be purchased from a chemical supply house.

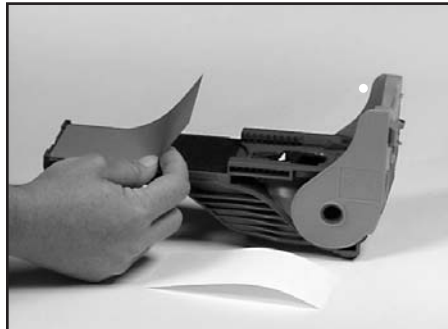
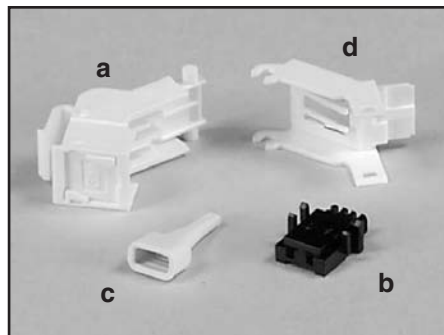

Note: Carefully follow safety, health and environmental information on container label or Material Safety Data Sheet for isopropyl alcohol being used.

4.2 Position the polishing puck assembly.

Remove the polishing puck assembly from the storage compartment beneath the polishing pad and place it on the dovetail on top of the hinged scribe cover.

Open the top of the polishing puck assembly by unlatching it from the side and opening it by its hinge to expose the inner cavity.

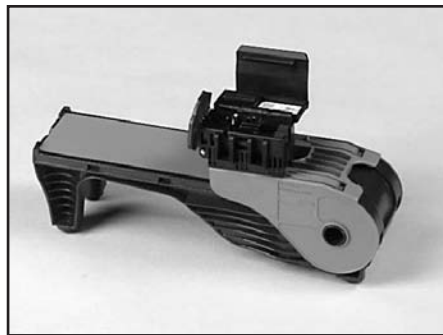

4.3 Position socket fiber holder in polishing puck assembly.

Ensure that the cavity is clean of debris and that the face of the puck is in the up position. Position a socket fiber holder into the cavity of the polishing puck assembly.

Tech Tip: Do not press on the activation cap of the SFH during insertion. It should be held by the four prongs only. (See insert)

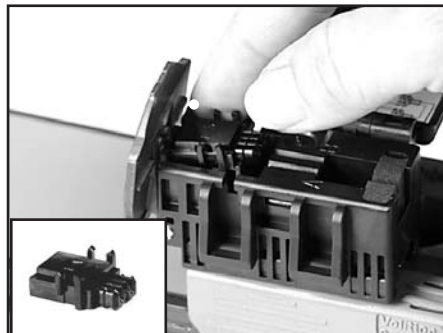

- 4.4 Adjust the jacket stripper so they cut only the outer jacket and not the Kevlar® strands. Move the stop location with a small, flat-head screwdriver until the hole size is correct.



4.5 **Remove outer cable sheath.**

Cut outer cable jacket at a length of 1 meter (39 in.) and set tool aside.

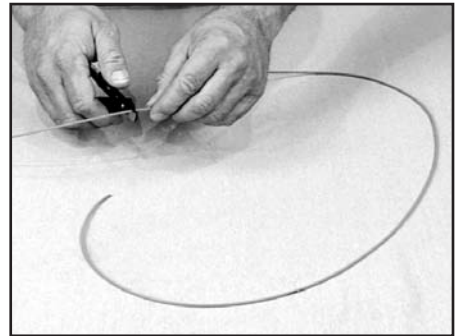

Remove the outer sheath by pulling on the end of the cable jacket, sliding it off the Kevlar® strands and inner optical fiber buffer tubes. Do not use the tool to slide the outer jacket off the inner Kevlar strands and buffer tubes. Discard the outer jacket.

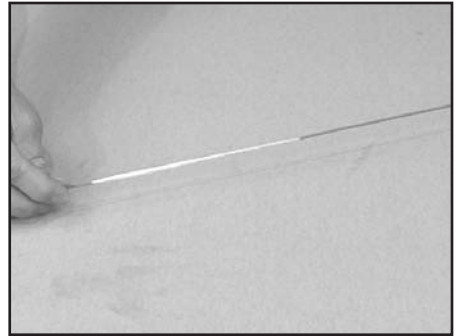

4.6 Remove Kevlar strands.

Use the snips to cut the Kevlar strands flush with the cable jacket. Discard the strands.

Use a cable tie to strain relief cable in patch panel or outlet within 2.5 mm (1 in.) of end of sheath.

Note: Do not over tighten the cable tie around the cable jacket. Pinched fibers may experience optical power loss.



4.7 **Even-up the fiber and buffer tube.**

If the fiber extends past the buffer tube, trim the end so the tube and fibers are the same length.

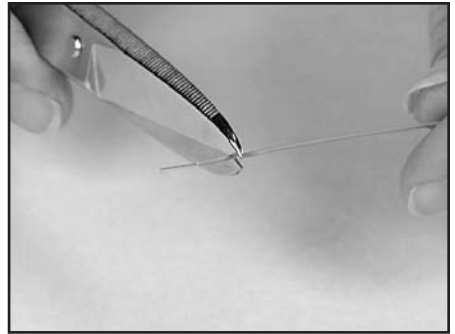

4.8 **Position boot.**

Place the boot onto the buffer tube, small end first. Slide the boot along the buffer tube until it is out of the way.

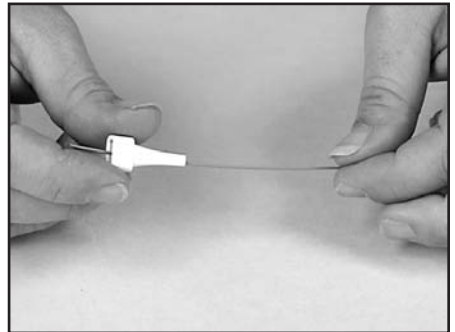

4.9 Remove buffer tube.

Verify that length guide is pushed flush against back of tool. Insert the buffer tube into the buffer tube stripper until it bottoms against the tool. Squeeze the handles of the tool together and pull the buffer tube off to expose the two 250 μ optical fibers.

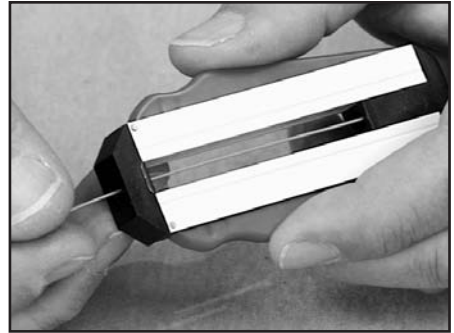

4.10 Strip the buffer coating from the fibers.

Insert both of the 250 μ fibers into the tube guide of the dual fiber stripper until the buffer tube is flush with the outer edge of the tube guide. Squeeze the handles of the dual fiber stripper together and pull the fibers out.

Note: Clean the stripper blades with the brush end of the cleaning tool when needed. See “Dual Fiber Stripper Maintenance” section.

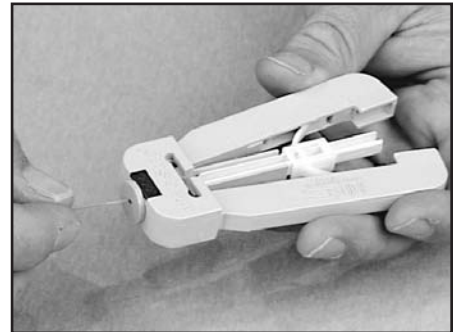

4.11 Clean the fibers.

Moisten a section of a lint-free wipe with isopropyl alcohol. Wipe the residue from the fibers using the moistened lint-free wipe until the fibers squeak.

Tech Tip: *All Isopropyl Alcohol should be reagent grade, 99% or better. The use of inferior alcohol will adversely effect interconnect losses. This can be purchased from a chemical supply house.*

Caution: *Care should be used when handling fibers so as not to break them, or to handle them in such a way that they could penetrate your skin.*

Note: *Carefully follow safety, health and environmental information given on container label or Material Safety Data Sheet for isopropyl alcohol being used.*

4.12 Thread the fibers into the holder.

Spread the fibers slightly apart between your fingers to feed them into the socket fiber holder. Refer to label inside polishing puck for duplex A-B crossover orientation. (e.g., patch panel A-to-B, outlet B-to-A). Every link must cross (i.e. patch panel to patch panel).

Tech Tip: *Make sure that the face of the polishing puck assembly is in the closed position before the fibers are inserted.*

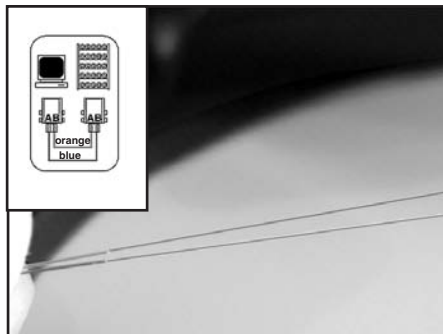

Slide the fibers along the fiber guide grooves of the polishing puck assembly and into the socket fiber holder.

Fiber insertion is complete when the color coded fibers enter the socket fiber holder and positively stop.

Tech Tip: *If resistance is felt when inserting the fibers, back the fibers out of the SFH and verify that all of the coating residue has been removed then reinsert. If resistance continues, it may be necessary to replace the SFH.*

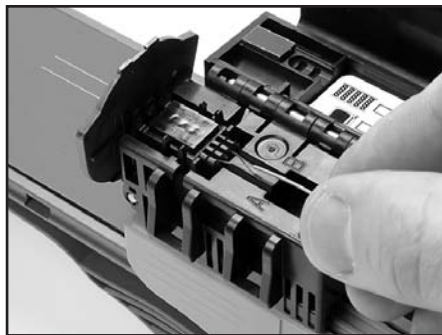

Place the buffer tube into the strain relief foam so that the two fibers are held with a slight bow in the socket fiber holder.

Caution: *Use care as bare fibers are now protruding through the face of the polishing puck.*

Caution: *Care should be used when handling fibers so as not to break them, or to handle them in such a way that they could penetrate your skin.*

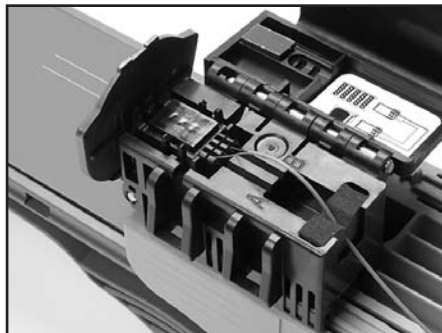

4.12 Actuate the fiber holder.

Rotate and close the top section of the polishing puck assembly by its hinge to actuate the socket fiber holder. The top section will latch with an audible click when it is fully closed.

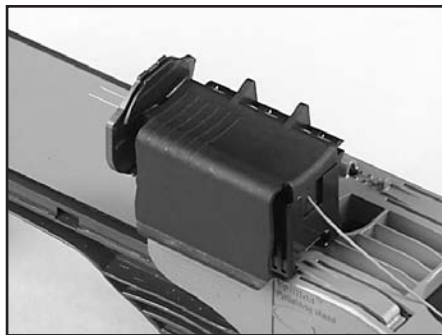

4.13 Scribe and polish fibers.

Open the hinged scribe cover by rotating the polishing puck assembly along with the dovetail to expose the scribe area.

Lift the polishing puck assembly off of the dovetail.

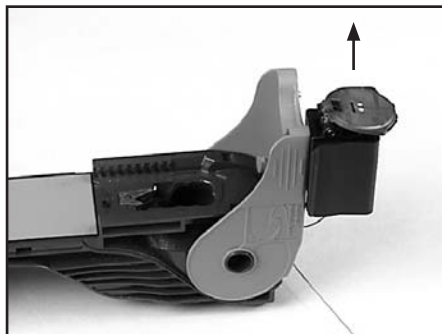

Place the polishing puck assembly into the scribe entrance by inserting the exposed fibers into the fiber stub basin.

Caution: *The catch basin of the polishing base should be emptied often and before storing. Safely dispose of fibers per your company's practice. The basin should only be used for fiber scraps, no other debris should be inserted.*

Tech Tip: *Ensure that the polishing face is in the correct orientation for the scribe motion. Note outline of puck face in scribe track. Also, care should be exercised in landing the polishing puck assembly into the scribe entrance.*

4.14 Move the polishing puck assembly smoothly through the scribe channel. As the puck slides through the scribe channel, continue the motion all the way across the lapping film.

Tech Tip: *Use caution when sliding puck through scribe channel. Keep pressure on polishing puck. Do not lift when going across scribe.*

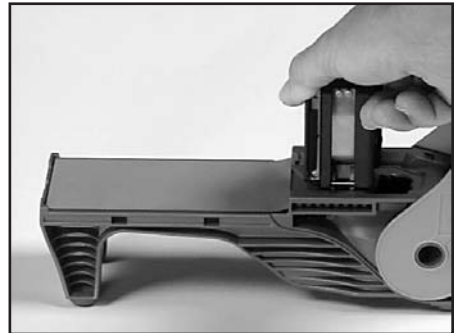
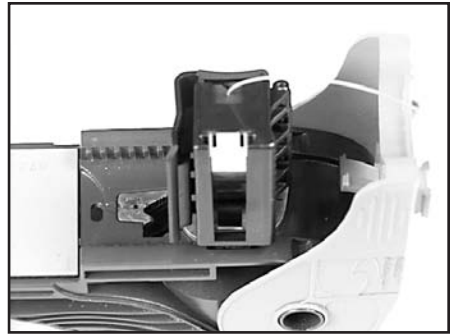

With medium pressure, slide the puck back and forth across the entire length of the lapping film 10–15 times. Use a different area of the film for each connector to extend film life.

4.15 Clean the fibers.

Place the polishing puck assembly back onto the dovetail. Moisten a lint-free wipe with isopropyl alcohol. Wipe the polishing puck face assembly using the moistened lint-free wipe.

Note: *The puck face should feel completely smooth with no fiber protrusion whatsoever. If resistance is felt, continue to polish until the face is smooth.*

Tech Tip: *All Isopropyl Alcohol should be reagent grade, 99% or better. The use of inferior alcohol will adversely effect interconnect losses. This can be purchased from a chemical supply house.*

Tech Tip: *This wipe can also be used to clean the lapping film. Clean after every connector for maximum film use.*

Note: *Carefully follow safety, health and environmental information on container label or Material Safety Data Sheet for isopropyl alcohol being used.*

Warning: *Do not touch cleave blade. Any material or solvent that contacts the blade can cause damage.*

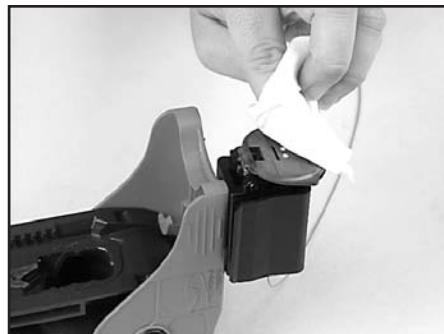

4.16 Inspect the fibers.

Attach the VF-45 puck adapter to the fiber microscope.

⚠ DANGER—LASER

DO NOT use the microscope to view active fiber signals under ANY circumstances. Active fiber signals contain laser light, and direct eye contact with laser light should be avoided. The failure to avoid direct eye contact with laser light can result in serious damage to the eye. The microscope may magnify the laser light in active fiber signals; direct eye contact with magnified laser light should be avoided.



Insert the polishing puck into the puck adapter. An audible click will be heard when the puck is fully seated. (Note: the adapter is keyed to accept the puck in only one direction).



Press the LED toggle switch to the desired illumination mode and focus image at the eyepiece.

The microscope will show either coaxial or oblique lighting views based on the direction of the toggle switch.

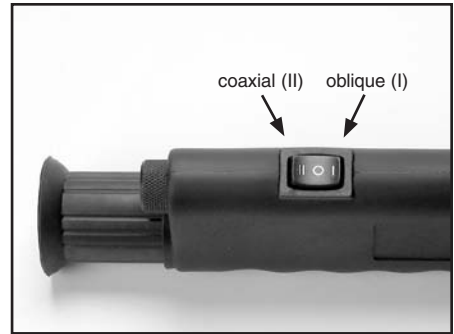

Slide the adapter side to side to view each fiber individually.



Examine the fiber ends for flaws. Any flaw in core of the fiber is unacceptable.

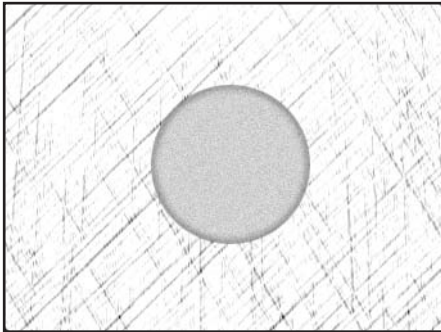

Coaxial Illumination—ACCEPTABLE

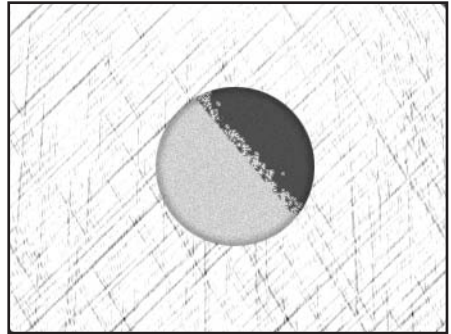

Coaxial Illumination—UNACCEPTABLE

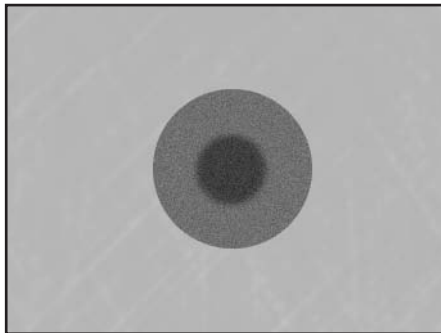

Oblique Illumination—ACCEPTABLE

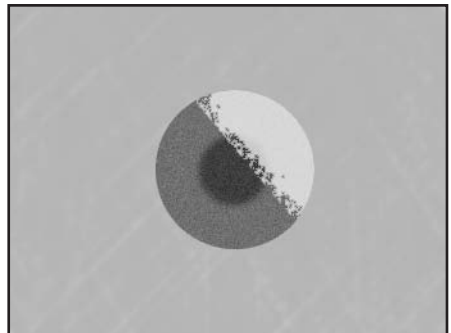

Oblique Illumination—UNACCEPTABLE

- 4.17 Rotate open the polishing face of the polishing puck assembly to expose the ends of the fibers. Use a cotton swab moistened with isopropyl alcohol to clean the fibers.

Clean both fibers by running the applicator along the length of the two exposed fibers, toward the fiber ends. Stroke past the ends of the fiber in an outward motion to make sure the entire shaft of fiber has been cleaned.

Tech Tip: Two strokes of the applicator on each side of the fiber should be adequate.

Note: Carefully follow safety, health and environmental information on container label or Material Safety Data Sheet for isopropyl alcohol being used.

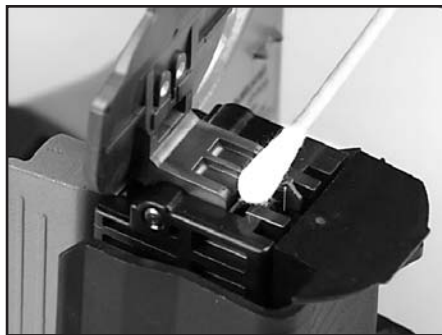

4.18 Socket Assembly.

Close the hinge scribe cover and open the polishing puck assembly top by releasing the latch.

Leave the fiber holder in polishing puck assembly.

Align the “pins” of the housing over the “hinge” of the fiber holder.

Snap the housing onto the socket fiber holder.

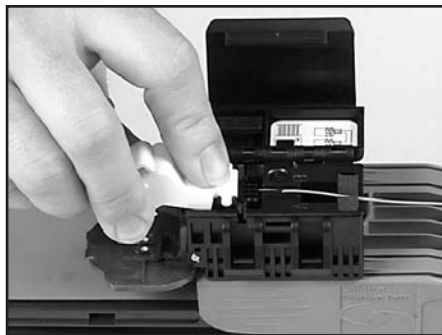

Remove the housing from the polishing puck assembly (the fiber holder will be attached to the housing).

Make sure the SFH sits flush in the housing.

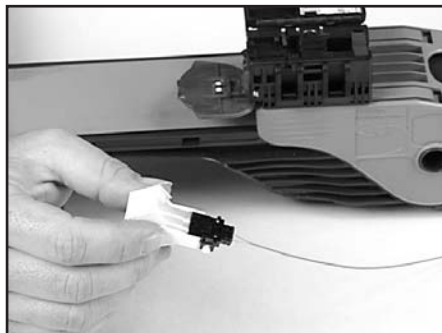

Hold the base and align the base “hinge” over the pins of the housing. Snap the “hinge” over the “pins.”

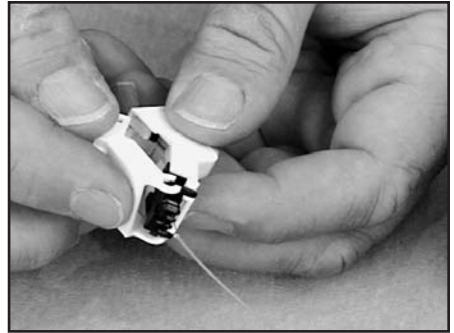

Rotate the base on the housing until the housing and base latch closed with an audible click.

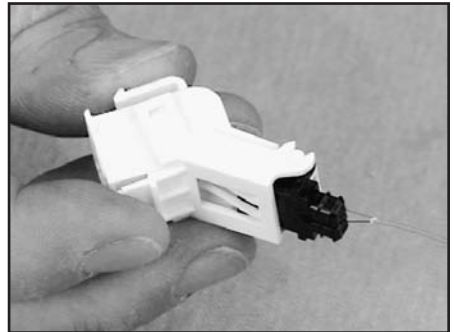

4.19 **Verify fiber position.**

Open the housing door with the wooden end of the cotton swab, and ensure that the fibers lie in the “V” grooves.

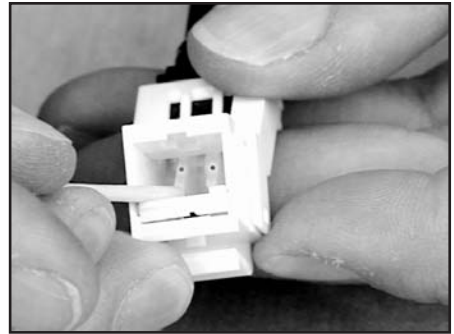

4.20 **Boot Placement.**

Slide the boot along the buffer tube onto the fiber holder until fully seated.

The VF-45™ socket termination is complete.

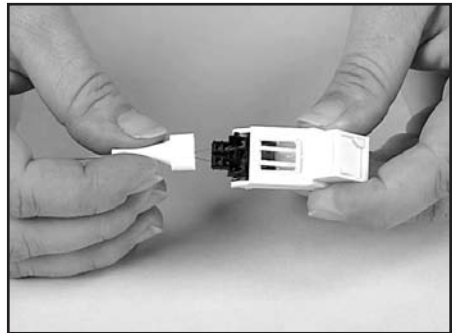

5.0 Tool Maintenance

5.1 Scribe Blade Assembly

The scribe blade assembly can be replaced by pushing down on the old blade assembly and sliding it out. A new blade assembly can then be inserted into the slot and pushed into place until the detent ball snaps in place.

Caution: *The diamond scribe blade is very sharp and can be damaged. Use care in this process. Do not touch blade!*

Warning: *Do not touch cleave blade. Any material or solvent that contacts the blade can cause damage.*

5.2 Wear indicator of puck face is located to the left of the ferrules. The face needs to be replaced when a white dot appears.

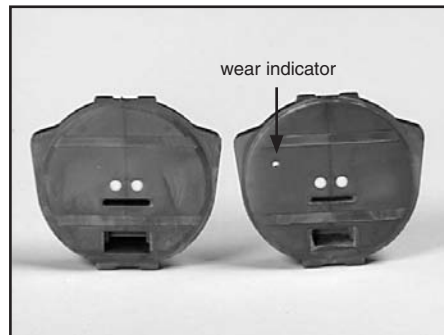
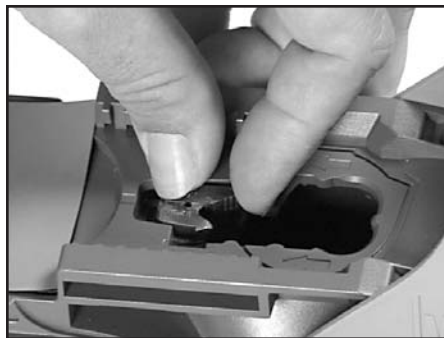

5.3 The face of the polishing assembly can be replaced in the fields by depressing the spring on the bottom of the puck assembly and snapping new face into place.

5.4 **If insertion of the fiber becomes difficult, inspect the fiber guide holes of the polishing face.**

Use the fiber view scope to inspect the fiber guide holes. Check for debris in the fiber guide holes.



5.5 **Clean the fiber guide holes of the polishing face.**

If the fiber guide holes become plugged, they may be cleaned by opening the face of the polishing puck, holding the alcohol bottle against the inside face area and directing alcohol through the holes. If alcohol stream does not dislodge debris, a piece of cleaning wire may be used to clean the holes (included in kit).

Note: Carefully follow safety, health and environmental information given on container label or Material Safety Data Sheet for isopropyl alcohol being used.

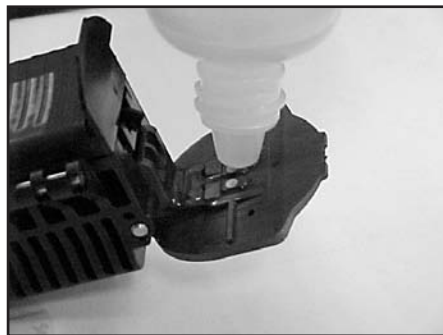

6.0 Dual Fiber Stripper Maintenance

6.1 Tube Guide

The stripper tube guide should be cleaned periodically to ensure good performance. Remove the tube guide by unlatching the tube lock with the white pushout tool. Pull the tube guide out of the pivot housing.

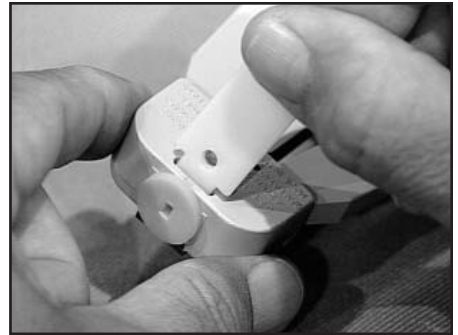

- 6.2 Clean the inside of the tube guide with compressed air. A length of unstripped fiber may also be used for cleaning if compressed air is not available. Also clean around the outside tip of the tube guide.

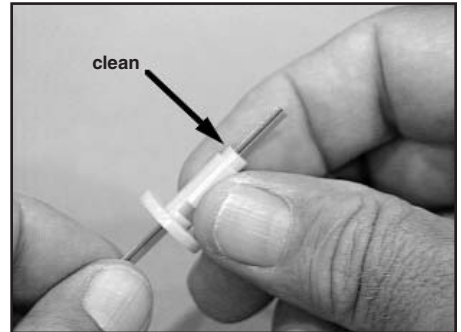

6.3 Stripper Blades - Cleaning

- a) If the stripper performance is unsatisfactory after the normal cleaning procedure, the stripper blades may need to be removed from the handle assembly for a more thorough cleaning.
- b) Remove the tube guide per section 6.1. Use the push-out tool to push the blades out of the handle assembly.

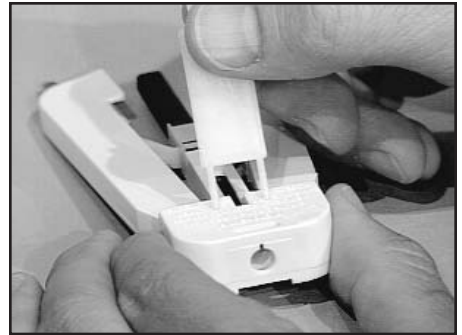

- 6.4 Remove all foreign material from the front and back sides of the blades, **especially around the semicircular region.**

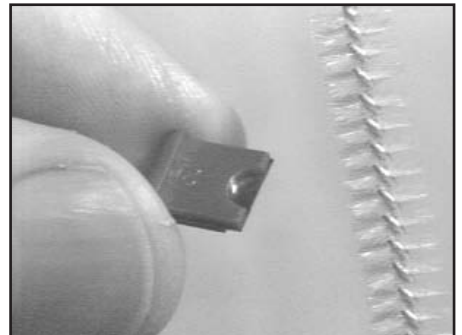

- 6.5 Replace the blades in the pivot housing. The molded recesses in the blades should face outward.

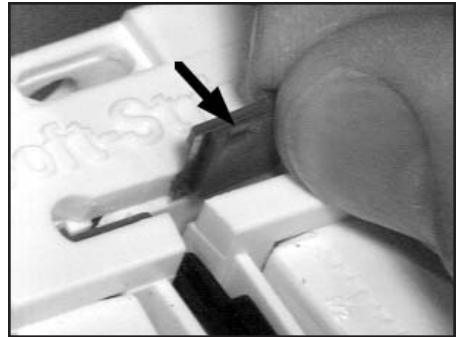

- 6.6 Insert the tube guide into the pivot housing. Secure the tube guide with the tube guide lock.

After installing blades, tube guide, and tube lock, close the handles once to align the blades.



6.7 Stripper Blades - Replacement

- a) If the stripper performance is unsatisfactory after a thorough cleaning, the blades need to be replaced.
Remove the blades.
- b) Place the new blades into the pivot housing.

7.0 3M™ VOL-0563M Microscope

- 7.1 In addition to being able to view the 3M™ VF-45™ puck end face with VOL-0563M Microscope, it also comes with additional adapters to enable to user to view the VF-45 male plug fibers or a standard ferruled connector fiber.

⚠ DANGER—LASER

DO NOT use the microscope to view active fiber signals under ANY circumstances. Active fiber signals contain laser light, and direct eye contact with laser light should be avoided. The failure to avoid direct eye contact with laser light can result in serious damage to the eye. The microscope may magnify the laser light in active fiber signals; direct eye contact with magnified laser light should be avoided.



7.2 3M™ VF-45™ Plug Adapter

Screw the VF-45 Plug adapter onto the microscope.

Insert the VF-45 connector into the adapter.

Note: *The adapter is keyed to accept this connector in only one direction.*

Press the LED toggle switch to the desired mode and focus the image using the eyepiece. Slide the adapter side to side to view each fiber individually.

Note: *VF-45 plug fibers are best viewed with coaxial illumination.*

7.3 Universal 2.5 mm Ferrule Adapter

Screw 2.5 mm ferrule adapter onto the microscope.

Slide a connector ferrule into the adapter until a positive stop is felt.

Press the LED toggle switch to the desired mode and focus the image using the eyepiece.

Focusing Hint: *If you have trouble finding the image, there is a simple trick. Load the connector and check to see that the light is on. Then, turn the focus adjustment clockwise until the tube hits a stop. At this point the objective is actually touching the sample. Look into the microscope and begin slowly turning the tube counter-clockwise. This will slowly back the lens away from the sample and eventually the fiber end face will come into focus.*



Technical Service

United States: 1-800-426-8688

Europe: 0-11-49-40-7520302

Asia: 0-11-65-354-2033

Spare Parts and Numbers

Cable Jacket Stripper	VOL-0560A
Snips	VOL-0560B
Buffer Stripper	VOL-0560C
Duplex Stripper	VOL-0560D
Replacement Blade	VOL-0562B
Puck Assembly	VOL-0560F
Polishing Face	VOL-0560G
Cotton Swabs	VOL-0560N
Lint Free Cloth	VOL-0560P
Alcohol Bottle	VOL-0560R
Polishing Station w/scribe blade assembly ..	VOL-0562H
Scribe Blade Assembly	VOL-0562J
Lapping Film	VOL-0562K
Carrying Case	VOL-0562S
Tool Pouch	VOL-0562M
Instructions	78-8097-8734-0
Cleaning Wires	80-6104-4345-1
Fiber Microscope 100X	VOL-0563M

3M, Volition and VF-45 are trademarks of 3M Company.
Kevlar® is a trademark of duPont.

Important Notice

All statements, technical information, and recommendations related to 3M's products are based on information believed to be reliable, but the accuracy or completeness is not guaranteed. Before using this product, you must evaluate it and determine if it is suitable for your intended application. You assume all risks and liability associated with such use. Any statements related to the product which are not contained in 3M's current publications, or any contrary statements contained on your purchase order shall have no force or effect unless expressly agreed upon, in writing, by an authorized officer of 3M.

Warranty; Limited Remedy; Limited Liability.

This product will be free from defects in material and manufacture for a period of one year from the date of purchase.

3M MAKES NO OTHER WARRANTIES INCLUDING, BUT NOT LIMITED TO, ANY IMPLIED WARRANTY OF MERCHANTABILITY OR FITNESS FOR A PARTICULAR PURPOSE. If this product is defective within the warranty period stated above, your exclusive remedy shall be, at 3M's option, to replace or repair the 3M product or refund the purchase price of the 3M product. **Except where prohibited by law, 3M will not be liable for any loss or damage arising from this 3M product, whether direct, indirect, special, incidental or consequential regardless of the legal theory asserted.**

3M

Communication Markets Division
3M Telecommunications

6801 River Place Blvd.
Austin, TX 78726-9000
800.426.8688
Fax 800.626.0329
www.3MTelecommunications.com



Recycled paper
40% pre-consumer waste paper
10% post-consumer waste paper

Litho in USA
© 3M 2004 78-8097-8734-0-C